

# HOW TO FIT MINI WALL STANCHIONS

## Assembly Instructions

### TOOLS REQUIRED:

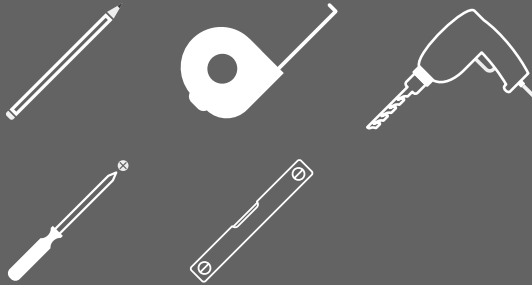

**!** Please check your opening for any hidden electrical wires and water pipes before / screwing.

**⊘** Screws not supplied. Use suitable screws and plugs.

V2

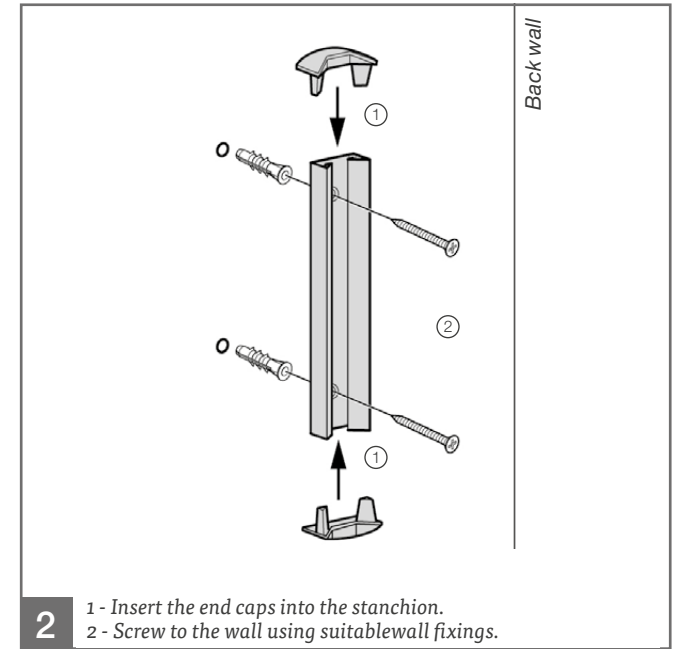
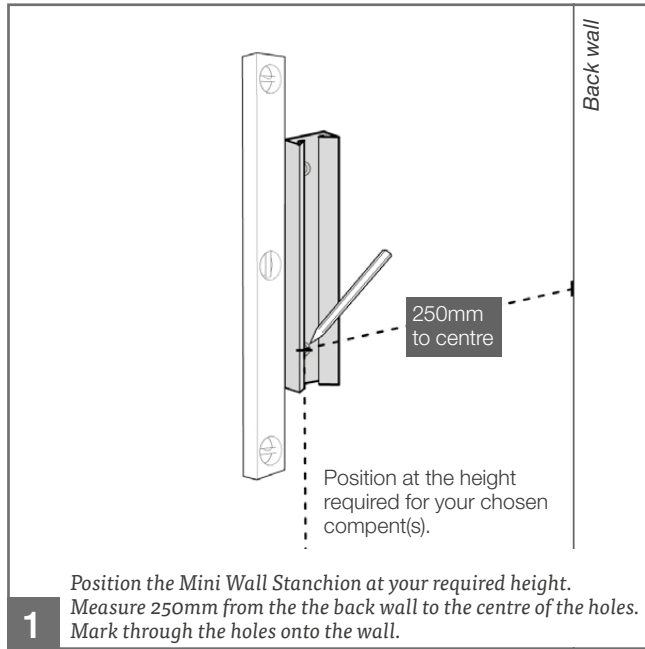

# A GUIDE TO FIXINGS



**Wall & Ceiling Fixings:** You must first identify the type of wall or ceiling you intend to fix product onto and then contact your local hardware store if the fixings supplied are not suited to your wall or ceiling type. Care and Maintenance: Safety: Always check the fitting and location to ensure your safety in and around the home. Fitting: From time to time check the fitting to ensure the wall plugs or screws do not become loose.

**IMPORTANT NOTE:** When drilling into walls always check that there are no hidden wires or pipes etc. Make sure that the screws and plugs being used are suitable for supporting your unit. Always consult a qualified trades person if you are unsure.

**Tips: 1.** Ensure you use the recommended drill bit to match the wall plug and hole size.

**Tips: 2.** Ensure you drill the hole straight, do not force the drill or enlarge the hole.

**Tips: 3.** Take extra care when drilling high walls, ceilings and ceramic tiles. Ensure wall plugs are inserted beyond the thickness of the ceramic tiles to avoid the tiles splitting or cracking.

**Tips: 4.** Ensure wall plugs are well fitted and are a tight fit in the drilled hole.

## Types Of Structures:

You can use one of the following types of wall plug if your walls are made of brick, breeze block, concrete, stone or wood.

### 1: General Purpose / Concrete or Block Work wall plug. NOT supplied.

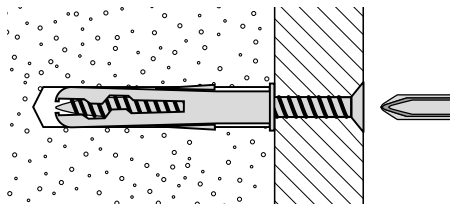

Generally aerated blocks should not be used to support heavy loads, use a specialist fitting in this case. For light loads, general purpose wall plugs can be used.

### 2: Plasterboard wall plug. NOT supplied.

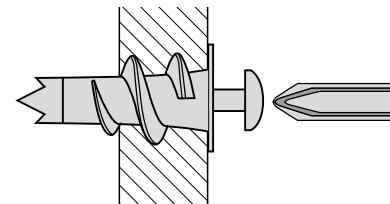

For use when attaching light loads on to plasterboard partitions.

### 3: Cavity Fixing wall plug. NOT supplied.

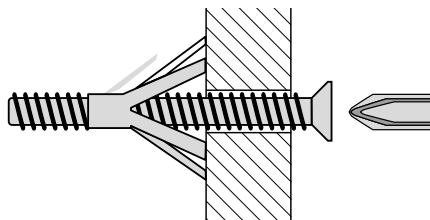

For use with plasterboard partitions or hollow wooden doors.

### 4: Wooden Structure. Screws provided.

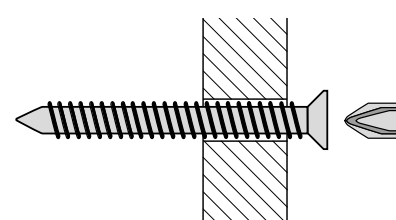

If you know you are fixing directly into a wooden batten, the screws provided do not require a plug.