





HOW TO BUILD THE INTERIOR DRAWER UNIT

Assembly Instructions

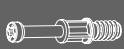

CONTENTS:

- 1x Top panel
- 1x Back panel
- 1x Side panel (right)
- 1x Side panel (left)
- 1x Drawer infill panel
- 1x Base
- 4x Soft close drawer runners (2x left, 2x right)
- 1x Metal infill strip
- 2x Drawer backs
- 2x Drawer sides (left)
- 2x Drawer sides (right)
- 2x Drawer fronts
- 2x Drawer bases

INTERIOR UNIT PACK

- | | | | | |
|---|---|---|---|---|
| 1 | 2 | 3 | 4 | 5 |
|  |  |  |  |  |
| 12x Euro screws | 14x Cams | 20x Wooden dowels | 14x Dowels | 2x Glue* |

DRAWER PACK

- | | | |
|---|---|---|
| 6 | 7 | 8 |
|  |  |  |
| 4x Dowels | 16x Wooden dowels | 4x Cams |

*A drop of glue needs to be added into all holes the wooden dowels are placed into (items 3 & 7).

RECOMMENDED:

- Tools: Pozidrive screwdriver

! We recommend assembling on a soft surface (e.g a carpet). If this isn't possible, use a protective cover on your hard surface floor.

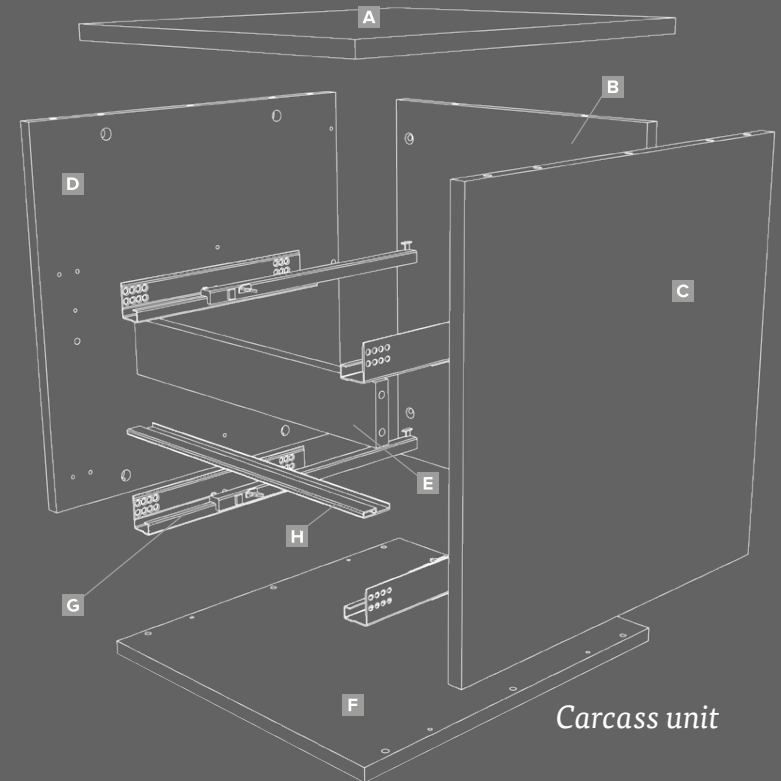

Carcass unit

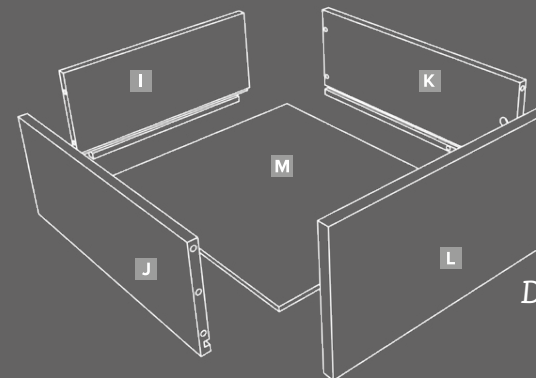

Drawer unit

